



Part No. 906800; 906800DHL

Model CF325XPRO24



**IMPORTANT!  
DO NOT DESTROY**

It is the customer's responsibility to have all operators and service personnel read and understand this manual.

**CORDLESS XPRO 30°  
FRAMING NAILER**

**OPERATING MANUAL**

# Contents

---

<b>Subject</b>	<b>Page</b>
Introduction and Warranty .....	2
An Overview of the Paslode Cordless Framing Nailer .....	3
Safety Instructions .....	5
Battery and Charging System .....	8
Fuel Cell and Metering Valve .....	10
Preparing the Paslode Cordless Framing Nailer for Use .....	13
Paslode Cordless Framing Nailer Operation .....	14
Fasteners and Applications.....	15
Servicing .....	16
Tool Schematic.....	18
Troubleshooting .....	20
Cleaning Procedure URL.....	21

The battery charger system meets all safety requirements for power tools.



 is a registered trademark of Illinois Tool Works Inc. © 2024

An Illinois Tool Works Company  
155 Harlem Avenue  
Glenview, IL 60025  
www.paslode.com

 Power Nailers are designed and assembled in the U.S.A.

Paslode® is a member of:



# Introduction and Warranty

## Paslode Cordless Framing Nailer Operating Manual

This manual is intended to acquaint you with the Paslode® Cordless Framing Nailer. Unlike other power fastening tools, the Cordless Framing Nailer is powered by an internal combustion linear motor. In simpler terms, your Cordless Framing Nailer is powered by a motor similar to the one that powers an automobile. The Cordless Framing Nailer ignites a fuel and air mixture to produce the energy to drive the motor, which in turn drives the fastener. As you will see, the Cordless Framing Nailer is totally self-contained. It carries its own fuel supply and battery, along with a supply of fasteners.

For ease of use, this manual is divided into sections (see Contents). Each section of the manual is written with you, the tool operator, in mind. We have left out all of the technical terms so that you can readily understand how to get the maximum performance from your Cordless Framing Nailer, and how to avoid damaging the tool or injuring yourself. But, to accomplish this, we need you to do two things:

- 1. READ THE MANUAL FROM COVER TO COVER BEFORE USING THE TOOL.**
- 2. FOLLOW ALL INSTRUCTIONS IN THE MANUAL.**

The Cordless Framing Nailer should be handled like other power fastening tools that you use. Like most tools, when used improperly it could result in injury. If you are going to allow others to use the Cordless Framing Nailer, it is your responsibility to make sure that they also read and comply with the instructions in this manual before attempting to operate the tool.

Should you have questions about the Cordless Framing Nailer, contact Technical Support at:

Email: [tech@paslode.com](mailto:tech@paslode.com)

Phone: 800-222-6990.

For the most updated version of this manual, always refer to the digital code below:



## Paslode Cordless Warranty and Limitations

Paslode warrants that new Cordless power fastening tools, parts and accessories will be free from defects in material and workmanship for the period shown below, after the date of delivery to the original user.

### ONE-YEAR LIMITED WARRANTY

A one-year warranty will apply to all parts, except those specifically covered by an extended warranty.

### FIVE-YEAR EXTENDED LIMITED WARRANTY

A five-year warranty will apply to all molded nylon parts:

- Motor Housing, Cap, and Grille
- Handle Halves and Actuator
- Trigger
- Magazine Parts

### CORDLESS 2 YEAR SERVICE PROMISE

Paslode will service the tool and replace all parts (including battery and charger system) which have failed during normal use for FREE for a period of 2 years from date of purchase.

For 2 Year Service Promise details and limitations see [paslode.com/service-and-support](http://paslode.com/service-and-support)

### WARRANTY STATEMENT

**This warranty is limited to tools sold and service requested in the United States. To obtain information on warranty service in the United States, refer to the Service Center listing that was provided with your tool.**

Paslode's sole liability hereunder will be to replace any part or accessory which proves to be defective within the specific time period. Any replacement part or accessory provided in accordance with this warranty will carry a warranty for the balance of the period of warranty applicable to the part it replaces. This warranty does not apply to part replacement required due to normal wear.

This warranty is void on any tool which has been subjected to misuse, abuse, accidental or intentional damage, use with fasteners, fuel, batteries, or battery chargers not meeting Paslode specification, size, or quality, improperly maintained, repaired with other than genuine Paslode replacement parts, damaged in transit or handling, or which, in Paslode's opinion, has been altered or repaired in a way that affects or detracts from the performance of the tool.

**PASLODE MAKES NO WARRANTY, EXPRESSED OR IMPLIED, RELATING TO MERCHANTABILITY, FITNESS OR OTHERWISE, EXCEPT AS STATED ABOVE, and Paslode's liability AS STATED ABOVE AND AS ASSUMED ABOVE is in lieu of all other warranties arising out of, or in connection with, the use and performance of the tool, except to the extent otherwise provided by applicable law. PASLODE SHALL IN NO EVENT BE LIABLE FOR ANY DIRECT, INDIRECT, OR CONSEQUENTIAL DAMAGES, INCLUDING, BUT NOT LIMITED TO, DAMAGES WHICH MAY ARISE FROM LOSS OF ANTICIPATED PROFITS OR PRODUCTION, SPOILAGE OF MATERIALS, INCREASED COST OF OPERATION, OR OTHERWISE.**

Paslode reserves the right to change specifications, equipment or designs at any time without notice and without incurring obligation.

# Overview of the Paslode Cordless Framing Nailer

## Description

The Paslode Cordless Framing Nailer is a self-contained, fully portable nailer that uses liquid hydrocarbon fuel to power a unique linear drive internal combustion motor.

As with any internal combustion motor, the Paslode Cordless Nailer will require periodic maintenance to keep it operating at its peak performance. The cleaning manual will instruct you on the proper cleaning of your tool. If additional services are required, contact your local Paslode service provider.

This Paslode Cordless Nailer can be operated in sequential and rapid fire mode.

### NOTE: Altitude Restriction

Paslode Cordless tools are powered by an internal combustion engine and are affected by altitude. The tool may lose power or not cycle consistently at elevations of 6000 feet (1,828 meters) or greater.

## Specifications

### Dimensions:

**Weight (with battery) 7.9 pounds (3.6 Kg)**

**Length 12 inches (305mm)**

**Width: 5 inches (127mm)**

**Height 14-1/2 inches (368mm)**

**Cycle Rate: Intermittent Operation – 2 to 3 nails/second**

**Maximum Cycle Rate: 1,000 shots per hour**

**NOTE: Exceeding these rates could cause tool to overheat, resulting in loss of performance or damage to tool components.**

**By using the Paslode Cordless Framing Nailer at its recommended cycle rate, you will be able to drive several thousand nails in a typical workday.**

**Fasteners: 30° paper tape collation**

**Minimum 2 inch x .113 dia. shank (50 x 2.87mm)**

**Maximum 3-1/4 inch x .131 dia. shank (90 x 3.15mm)**

**Magazine Capacity: 1 nail strip + 5 nails.**

**Battery : 7V DC - Provides enough energy to drive approximately 6000 fasteners on a full charge.**

**Fuel Cell: Paslode Framing Fuel Cell. Liquid hydrocarbon- Provides enough fuel to drive approximately 1200 fasteners.**



# Overview of the Paslode Cordless Framing Nailer



QUICK RELEASE-NOSE PLATE ASSEMBLY



TOOL REST FIXTURE



BYPASS FOLLOWER



SOFT GRIP HANDLE



EASY-LOAD MAGAZINE



DEPTH OF DRIVE ADJUSTMENT



LED PANEL SHOWING BATTERY STATUS AND FIRING MODE



WORK CONTACTING ELEMENT WITH AGGRESSIVE TIP FOR TOE-NAILING



ADJUSTABLE UTILITY HOOK



OFF



ON

BATTERY OFF / ON

# Safety Instructions

The following safety instructions have been included in this booklet to provide you with basic information necessary for safe operation of the Paslode Cordless XPro 30° Framing Nailer.

In addition to these instructions, there is additional training content on Paslode.com

**DO NOT ATTEMPT TO OPERATE THIS TOOL UNTIL YOU HAVE READ AND UNDERSTAND ALL SAFETY PRECAUTIONS AND MANUAL INSTRUCTIONS.**

	 <b>WARNING</b>
	<b>Always wear EYE and EAR safety gear when working with or in the vicinity of the Paslode Cordless Framing Nailer.</b>

1. Eye protection must meet the requirements of ANSI Z87+ and should have side shields for increased protection.
2. NEVER ASSUME THE TOOL IS EMPTY.
3. NEVER ENGAGE IN "HORSEPLAY" WITH THE TOOL.  
The Cordless Nailer is not a toy – it is a tool. Careless and improper use may result in a serious accident.
4. NEVER CARRY THE TOOL WITH YOUR FINGER ON, OR SQUEEZING THE TRIGGER.  
This practice may result in the accidental discharge of a fastener.
5. NEVER OPERATE A MALFUNCTIONING TOOL.  
Refer to the servicing or troubleshooting section of this manual to correct the problem. If the problem cannot be corrected, stop using the tool and report it to your supervisor or Paslode representative.
6. DO NOT LOAD FASTENERS WITH THE TRIGGER AND/OR WORK CONTACTING ELEMENT PRESSED IN.  
A fastener may be accidentally discharged.
7. NEVER OPERATE THE TOOL WITH THE WORK CONTACTING ELEMENT REMOVED OR DISABLED.  
This device helps reduce the possibility of accidental fastener discharge by preventing the tool from operating until it is completely against the work surface.  
NEVER operate the tool if the Work Contact Element is not working properly.
8. ALWAYS POINT THE TOOL AWAY FROM YOURSELF AND OTHERS WHEN CLEARING A JAM OR REMOVING FASTENERS.  
Pull the follower slightly back and push the release lever. Tip the tool nose up slightly and fasteners should slide out of the rear of the magazine. If fasteners are jammed, refer to the appropriate servicing section of this manual.
9. NEVER OPERATE THE NAILER IF PARTS ARE LOOSE, DAMAGED OR MISSING.
10. DO NOT DRIVE FASTENERS INTO KNOTS OR ON TOP OF OTHER FASTENERS.  
A fastener may ricochet and cause serious injury.
11. OPERATE THE TOOL ONLY ON THE WORKPIECE.

	 <b>WARNING</b>
	<b>The Cordless Framing Nailer should be operated only when it is contact with the work surface. When fastening thin materials such as plywood, be sure to position the tool so that the fastener is driven into the underlying piece.</b>



# Safety Instructions

	<p><b>! DANGER</b></p>
	<p>The Cordless Framing Nailer is an internal combustion device. It produces hot exhaust gases that may ignite flammable materials. This tool must not be used in a combustible environment or in the presence of combustible materials, such as flammable chemicals, adhesives, gasoline, or solvents.</p>

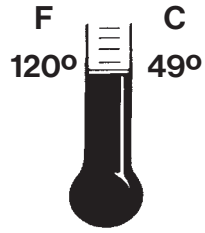
	<p><b>! WARNING</b></p>
	<p>Do not expose the tool to temperatures in excess of 120°F (49° C). Fuel and/or the battery may burst, releasing flammable gas.</p>

	<p><b>! WARNING</b></p>
	<p>Do not attempt to operate this tool until you have read and understood all safety precautions and manual instructions.</p> <p>Failure to follow all safety precautions and instructions may result in a permanent loss of vision, serious personal or even fatal injury, property damage and/or tool damage.</p>

	<p><b>! WARNING</b></p>
	<p>This tool must be operated <b>only in a well-ventilated environment</b>, because the tool exhausts carbon monoxide similar to a gas chainsaw or lawn-mower. Exposure to carbon monoxide may cause dizziness, nausea, or unconsciousness.</p>

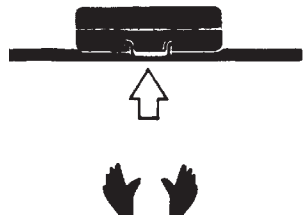
	<p><b>! WARNING</b></p>
	<p><b>ALWAYS</b> keep the Cordless Framing Nailer, fuel cell, battery, and battery charger out of the reach of children.</p>

# Safety Instructions



12. NEVER DRIVE FASTENERS INTO AREAS WITH CONCEALED HAZARDS.

Always check the area behind the work surface for electrical wiring, gas pipes, water pipes, sewer drains, or other potential hazards.

13. ALWAYS MAINTAIN SECURE AND UNOBSTRUCTED FOOTING WHEN ON LADDERS, PLATFORMS, OR OTHER HIGH LOCATIONS.

	 <b>WARNING</b>
	<p>Never over-reach, since tool recoil may cause a loss of balance. Always be aware of edges and drop-offs when nailing on rooftops and other high locations. Keep them in full view.</p>



14. ALLOW ONLY QUALIFIED PERSONNEL TO OPERATE THE CORDLESS FRAMING NAILER.

	 <b>WARNING</b>
	<p>Only persons who have read and fully understand all tool operation, safety, and maintenance instructions should be allowed to operate the tool.</p>

## Battery Disposal:

The Paslode batteries contain lithium and should be recycled or disposed of properly. It is illegal in some areas to place a lithium battery into the trash or solid waste stream. You may contact your local recycling center for information on where to return the spent battery or call 1-800-822-8837 for information on battery recycling in your area.

15. PROPERLY STORE FUEL CELL.

	 <b>WARNING</b>
	<p>Always store fuel cells where they will not be exposed to an open flame, sparks, or temperatures above 120° F (49° C).</p>



16. ALWAYS STORE THE TOOL WITH THE FUEL CELL AND BATTERY REMOVED.

Store the fuel cell in the case with the Cordless Nailer.

17. KEEP THE TOOL CLEAN.



A clean tool is less likely to jam or malfunction.

18. KEEP YOUR HANDS CLEAR OF THE WORK AREA SURFACE.

	 <b>WARNING</b>
	<p>A fastener may exit at an angle unexpectedly and cause injury.</p>

## CHARGING SYSTEM SAFETY INSTRUCTIONS!

**IMPORTANT SAFETY INSTRUCTIONS!  
SAVE THESE INSTRUCTIONS!**

 <b>DANGER</b> 
<p><b>TO REDUCE THE RISK OF FIRE OR ELECTRIC SHOCK, CAREFULLY FOLLOW THESE INSTRUCTIONS</b></p>

**For connection to a supply outside North America, use an attachment plug adapter of the proper configuration for the power outlet, if needed.**





# Battery and Charging System

## Battery and Charging System

The Paslode Cordless tool comes with a rechargeable Lithium Ion (Li-ion) battery and its own charging system. This charging system is the **only one that will work with Paslode Li-ion batteries**. The first step in preparing a new tool for operation is to fully charge the battery. **New batteries are shipped partially discharged and must be charged prior to first use**. Batteries will take 5 minutes to 1.5 hours (time will be dependent on the amount of discharge within the battery) to recharge.

## Important Charging Notes

	 <b>WARNING</b>
	<b>CHEMICAL / EXPLOSION HAZARD</b> Read ALL instructions before charging or using battery. Failure to follow ALL instructions may result in fire, severe burns, or release of toxic materials,

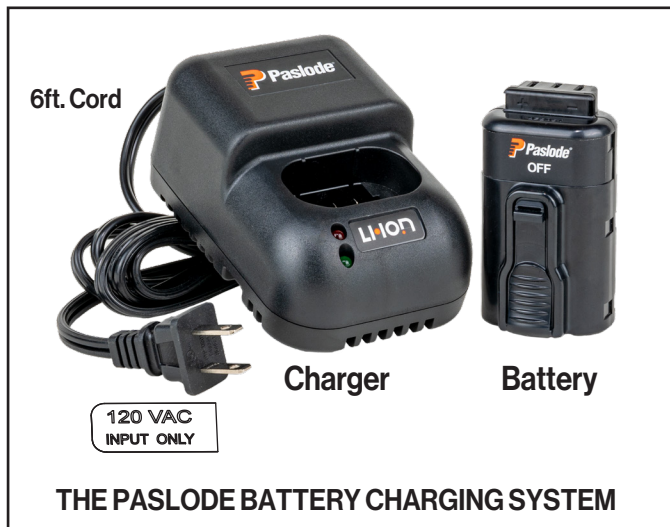

## Battery Disposal

The Paslode batteries contain lithium and should be re-cycled or disposed of properly.

You may contact your local recycling center for information on where to return the spent battery or call 1-800-822-8837 for information on Li-ion battery recycling in your area.

## Charging System Accessories:

Battery Charger - Part No. 902667

## Charging Instructions

1. Remove the charger unit from the tool case and plug it into a 120V AC outlet. Set the charger base on a stable surface. A green light will come on to indicate the power is on and the charger circuit is ready.
2. Remove the battery from tool or case and insert terminals down into the charger. The red light will come on indicating that the battery is charging and the green light will go out.

### NOTE

If battery is completely discharged, the red light and green light may alternate back and forth for up to 20 minutes. This safety feature slowly recharges the battery until it is ready to accept the full charging current. If the red and green lights continue to alternate after 20 minutes, replace the battery.

3. After charging is complete, the red light will go out and the green light will come on, indicating that the battery is fully charged. The charger will keep the battery at full charge until it is removed.
4. Unplug the charger from the 120V AC outlet.

## CHARGING TIMES:

<b>First charge</b> (new battery)	<b>1.5 hours</b>
Discharged Battery:	5 minutes to 1.5 hours
	2 minute quick-charge for 200 shots

## CHARGING DON'TS:

1. Do not charge battery outdoors or in temperatures above 113°F (45°C) or below 32°F (0°C).
2. Do not allow metal objects to come in contact with the battery terminals.
3. Do not puncture or attempt to open battery case or cells.
4. Do not store battery where it will be subjected to temperatures above 120°F (49°C).
5. Do not incinerate battery.
6. Do not use a defective battery charger, one that overheats and/or smokes when plugged in.
7. Do not immerse the battery or charger in water.

# Battery and Charging System

## Inserting Battery

1. Load the battery, contacts first, into the Cordless Framing Nailer.
2. Push battery fully forward into its locked position.
3. To remove battery, push down on locking tab and slide battery out.

NOTE: If battery is left in tool for an extended period of time in the normal operating position, the battery will discharge completely and will require recharging.

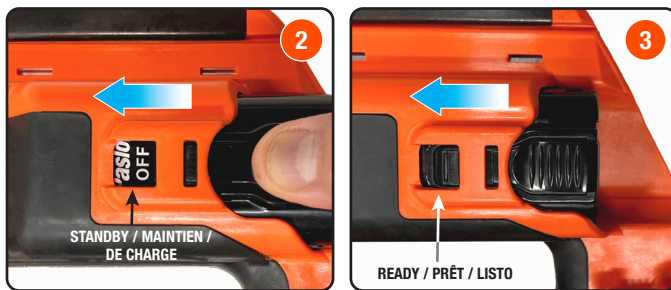

## Battery Standby

The battery can be placed in the standby position if the tool is not going to be used for a period of time.

To place the battery into the standby position, push down on the locking tab and slide the battery back so that the locking tab engages into the standby position in the handle.

## Tool Actuation Modes

The tool will operate in Sequential Mode out of the case. Every time the battery is inserted into the ON position, the tool starts in Sequential Mode.

### SEQUENTIAL MODE OPERATION

In Sequential Mode, fire the tool by first depressing the nose against the workpiece and then pulling the trigger for every shot.

### TO ENTER RAPID FIRE MODE

Press and hold the Rapid Fire button for 3 seconds. The blue LED will turn on. This light will switch off if the tool is idle for 1 hour OR if the battery is removed from the ON position.

## Battery Indicator LEDs

When using the Cordless XPro Framing Nailer, the LED lights on the handle of your tool will provide you with important operational information.



When the battery is first installed, these 2 LEDs will indicate your state of charge. If battery charge is >60%, both LEDs will be green.



If battery charge is 20-60%, only this LED will be green.



If the battery charge is <20%, this LED will be red. When battery approaches 0%, the LED will flash red for 90 seconds and then the tool will shut down.



After a few seconds, the battery level indicators will turn off and the power LED will begin to flash green, indicating the tool is on.



Hold Rapid Fire Button in for 3 seconds.



LED Lights Blue to indicate Rapid Fire is ON.

### TO EXIT RAPID FIRE MODE

Press and hold the Rapid Fire button for ½ second. The blue LED will turn off. The tool will now return to Sequential Mode.

# Fuel Cell

## Fuel Cell

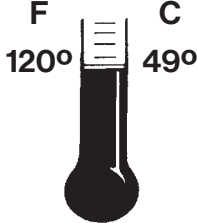
	 <b>DANGER</b>
	<p><b>EXPLOSION / FIRE HAZARD</b></p> <p>Read ALL safety instructions before using or handling the fuel cartridge. Failure to follow ALL instructions may result in explosion or fire. This may cause severe personal injuries or property damage.</p>
	<p>Keep the fuel cell away from heat, sparks, and open flame. Do not smoke when handling or operating tool or fuel cartridge.</p>
	
	<p>Exposure to temperatures above 120°F (49°C) may cause the fuel cell to burst, releasing flammable gas.</p>

 <b>WARNING</b>
<p>Sunlight can raise the inside temperature of an unventilated car or van to above 140°F (60°C).</p> <p>Never puncture or attempt to open the fuel cell, it is non-refillable.</p> <p>Never incinerate, reclaim, or recycle the fuel cell.</p> <p>Never smoke while installing the fuel cell.</p> <p>Never inhale the spray.</p> <p>Keep out of the reach of children.</p> <p>Store fuel cell(s) in well-ventilated areas only.</p>

There is a second container inside the fuel cell. The inner container holds the fuel. The space between the inner container and the outer cylinder is filled with a gas, called the propellant, which is under pressure.

To eject the fuel, propellant pressure squeezes the inner fuel container. This squeezing action ensures that all the fuel is used, and that the Cordless Nailer can operate in any position.



However, over time the propellant pressure diminishes until it is no longer able to squeeze the inner fuel container. This is why a nailer using a fuel cell beyond the "Best Use Before" date may not work consistently or at all.

If you expose the empty fuel cell to extreme temperatures, the propellant gas will expand and could cause the container to burst, releasing flammable gases.

The fuel contains a small amount of oil to keep the tool lubricated during use. **It is not necessary to oil the tool during normal operation.** When cleaning the tool, use only Paslode Cordless tool oil. Using oils not formulated for the Paslode Cordless Tool, may cause loss of power and may damage the internal parts of the tool's motor.

<b>NOTE</b>
<ol style="list-style-type: none"> <li>1. Never attempt to refill the cell! Replace with fresh fuel cell, and dispose of spent cell properly.</li> <li>2. When replacing fuel cell also clean or replace air filter for optimum tool operation.</li> </ol>

<b>NOTE: Altitude Restriction</b>
<p>Paslode Cordless technology is powered by an internal combustion engine, which is affected by altitude. The tool may lose power or become erratic at elevations of 6000 feet or greater.</p>

 <b>DANGER</b> 
<ol style="list-style-type: none"> <li>1. Do not attempt to remove or reuse the Paslode Framing Fuel Cell.</li> <li>2. Do not attempt to install the fuel cell cap on other fuel cells. This may result in damage to the tool and injury to the user and bystanders!</li> </ol>



# Fuel Cell

---

## Note:

**Paslode Fuel Cells are marked with a “Best Used Before” date on the bottom of the can. For maximum performance use fuel before the “Best Used Before” date.**



 <b>DANGER</b> 
<p><b>Paslode Cordless Fuel Cells are flammable. Do not remove fuel cartridge cap or install on other fuel cells!</b></p>

## ***Paslode Cordless Fuel Cell Disposal Guidelines***

Paslode, the industry leader in cordless technology, provides this information to assist users with the proper disposal of discarded fuel cells. Acceptable disposal options vary depending on the type of fuel cell user. All users must consider federal, state, and local solid waste regulations to ensure that discarded fuel cells are disposed of properly. Users must contact their local solid waste authority for further guidance.

Discarded fuel cells (used or unused) may be considered hazardous waste under the Resource Conservation and Recovery Act (RCRA). In general, “household wastes” generated by homeowners and their contractors are exempt from hazardous waste regulation because those wastes are expressly excluded from the definition of hazardous waste. For example U.S. EPA has excluded as “household waste” aerosol cans that contain residual product and propellant. Thus under federal hazardous waste

regulations homeowners and contractors may dispose of discarded fuel cells as general refuse in a properly permitted municipal landfill. These users must still contact their local solid waste authority to determine if any state or local regulation prohibits or restricts such disposal.

Paslode takes no responsibility for improper fuel cell disposal. Proper disposal remains the responsibility of sellers and users. All sellers and users must contact their local solid waste authority to determine if any federal, state, or local regulation prohibits or restricts disposal. Users may obtain more information about U.S. EPA hazardous waste regulations at the following internet address: [www.epa.gov](http://www.epa.gov)

Alternatively users may contact U.S. EPA’s Toxic Release Information Center at 1-800-424-9346 to receive more information.

# Fuel Cell

## CORRECT FUEL CELL LOADING PROCEDURE



**1**  
To open - Push forward, lift then back



**2**  
Raise fuel tube block assembly, it will lock in up position



**3**  
Load fuel cell



**4**  
Carefully align fuel adaptor and cell stem



**5**  
To close - Push forward, then down to lock fuel door

# Preparing the Paslode Cordless Framing Nailer for Use

## Fasteners

The Paslode Cordless Nailer drives Paslode RounDrive® and D/Head nails, which have been collated into strips. The use of nails that do not meet Paslode standards could cause tool damage and void your warranty. Paslode nail sizes and types are illustrated in the Fasteners and Applications section.

## Loading Fasteners



Drop the nail strip into the empty magazine.



Pull the follower up past the last nail. Avoid letting the follower slam forward into the nails.



Tool is ready to fire.

## Unloading Fasteners

Pull the follower back slightly and push the lever.

Position the tool upright allowing the nail strip to drop out.

Lockout Feature
<p>When the follower reaches the lockout area (5 nails remaining) the tool will automatically lock to prevent it from firing. To unlock the tool, simply reload another strip of nails.</p> <p>The purpose of this feature is to prevent needless blank cycling, which could mar woods, waste fuel, and damage tool components. Five (5) nails will be left in the magazine when the follower reaches the lockout area. When changing fastener length or loading the tool you should inspect the magazine and nose for any fasteners left in the tool. These nails will not be visible unless you open the quick-clear of the tool.</p>

## Hot Weather Operation

The Cordless Nailer requires cooling of the motor assembly to work properly. The fan normally provides the necessary air flow to permit continuous operation. Whenever the Nailer is idle for extended periods, keep the fuel and tool out of direct sunlight and in surroundings where temperatures will not exceed 120°F (49°C). After extended periods of continuous use, it may be necessary to cool the motor by setting tool aside for 10-15 minutes or until the tool operates normally. An overheated tool may not drive nails completely or may operate erratically.

## Cold Weather Operation

Fuel at cold temperatures lose the required propellant force. Bring the tool, battery, and fuel cartridge above minimum operating temperature without direct exposure to flame, and check the battery.

## Paslode Cordless Framing Nailer and Outdoor Weather

Use the Cordless Framing Nailer outdoors, in clear weather, when the nailer, fuel cartridge, and battery are between 14°F (-10°C) and 120°F (49°C).



**The Cordless Framing Nailer should not be used in the rain or where excessive moisture is present. The use of the Paslode Cordless Technology under these conditions may result in damage to tool components and cause tool to malfunction.**

# Paslode Cordless Framing Nailer Operation

## Cold Weather Operation (Continued)

It will be necessary to repeat this procedure several times until the temperature of the tool warms up enough to operate in its normal mode.

Once the tool reaches operational temperature the tool will generate its own heat and will function normally.

If the tool sits for an extended period of time and cools down it may be necessary to repeat these steps.



### WARNING

During the warm-up process, never expose the tool, fuel cell, or battery to flame.



### CAUTION

This tool must be operated in a well ventilated environment, because the tool exhausts carbon monoxide similar to a chainsaw or lawn mower. Exposure to carbon monoxide may cause dizziness, nausea, or unconsciousness.



**PRESS WORK CONTACTING ELEMENT AGAINST THE WORK SURFACE.**

Fan motor starts, fuel is injected into combustion chamber and mixed with air by the fan.



**SQUEEZE TRIGGER**  
Spark plug ignites the fuel/air mixture, driving the piston assembly down on the fastener.



**RELEASE TRIGGER - LIFT TOOL**  
Combustion chamber opens. Fan exhausts, cooling internal components. Note: The fan will run for approximately 10 seconds after the last nail is driven. After rapid firing (at least 32 times in 80 seconds), the fan will run for 60 seconds to cool the tool.



### DANGER

The work contacting element and nose will become hot after prolonged or rapid use. If it becomes necessary to adjust the work contacting element, avoid touching with bare hands.

## Depth of Drive Adjustment

**Remove the battery before adjusting the depth of drive.**

The depth of drive adjustment is made by adjusting the work contacting element. Squeezing the probe stop release buttons toward each other will allow the work contacting element to be moved up or down.

If the tool is over-driving (the nail head is driven below the surface of the wood), the work contacting element should be moved down slightly. If the nails stand up (the head is not flush with the work surface), the work contacting element should be moved up slightly. The indicator marks are set at 1/10" (2.5mm) increments with a total range of 1/2" (13mm).

Adjust the work contacting element to get the nail head depth to meet job requirements.



## Adjustable Utility Hook

The adjustable utility hook can be used as a belt or rafter hook. To adjust the utility hook, push the black button in the direction of the arrow and rotate it to the desired position.



# Fasteners and Applications

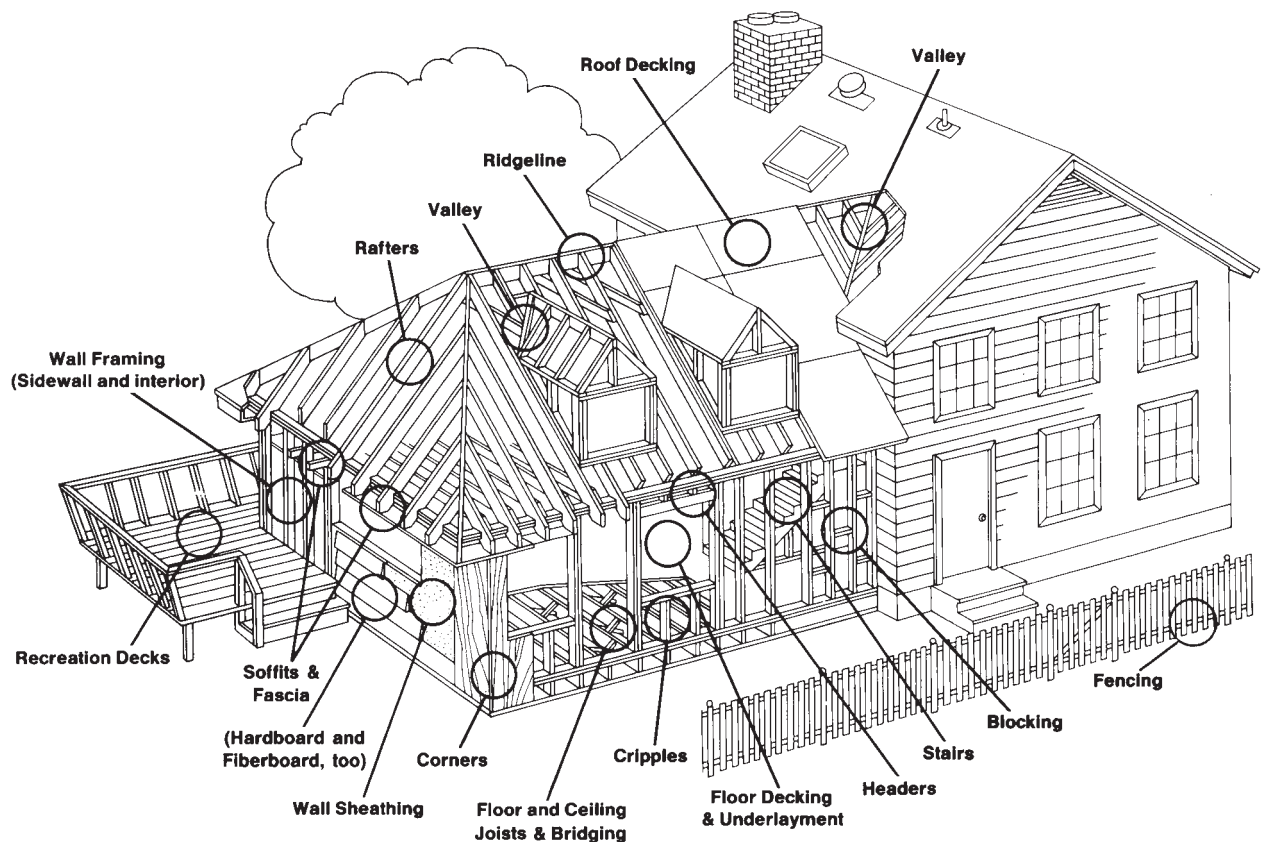

## Fasteners

**Smooth Shank** - For general construction, carpentry and framing: the most popular and versatile.

**Ring Shank** - The ring shank provides improved withdrawal resistance for applications where the resistance from smooth shank fasteners is not adequate: floor decking, crating, pallets.

**Hardened Steel** - For attaching wooden plates to green concrete foundations; 2X furring strips to cinder block.

**HDG**- These nails are hot dipped galvanized with a baked on polymer coating. They offer the highest corrosion resistance of any galvanized nail. These nails should be used where higher corrosion resistance is required to retard rust and rust staining. Recommended for use in natural wood siding, such as cedar, redwood, cypress and preservative treated lumber. (Not for use in all-weather wood foundations.)

The Paslode Cordless Framing Nailer is not recommended for use with 3" (75mm) and longer Ring Shank nails in pressure treated lumber.

**Note: For Australia and New Zealand, nail sizes, coating types and applications may vary. Please check your local building code regulations.**

SIZE	TYPE	APPLICATION
2" x .113 (6D) (50 x 2.87 mm)	Common Ring Shank	Underlayment, wall sheathing, roof and floor decking, siding
2" x .113 (6D) (50 x 2.87 mm)	Common ring shank, HD Galv, GalvGuard™	Fencing, siding
2-3/8" x .113 (8D) (60 x 2.87 mm)	Cooler ring shank HD Galv, GalvGuard™	Roof & floor decking, underlayment, sheathing
3" x .120 (10D) (76 x 3.05 mm)	Coated nail	Remodeling
3" x .120 (10D) (76 x 3.05 mm)	Ring shank, HD Galv, GalvGuard™	Fencing, recreational decking, siding, tile roofs
3" x .131 (10D) (75 x 3.33 mm)	Coated nail	Framing
3-1/4" x .131 (12D) (82 x 3.33 mm)	Coated nail	Framing



# Servicing

## Restrict Field Service to the Following

- CHECKING THE CHARGE LEVEL OF THE BATTERY
- RECHARGING THE BATTERY
- CHECKING THE FUEL CELL
- REPLACING THE FUEL CELL
- CLEANING/REPLACING THE AIR FILTER
- CLEARING A JAM
- CLEANING THE TOOL (See cleaning Manual)
- REPLACING TIP

Attempts to go beyond these procedures could result in serious personal injury or damage to the Cordless Nailer and voiding the warranty.

There are certain problems you may encounter when you are using the Cordless Nailer that you will be able to correct on the work site. The following field service procedures are the only service procedures you should attempt. Anything else that may appear wrong with the Cordless Nailer should only be diagnosed and repaired by a fully trained service technician. If you have any reason to believe that your problem is beyond the service procedures in this manual, contact Paslode.



### DANGER

**Never attempt any maintenance of a Paslode Cordless tool without first removing the fuel cell and battery. Maintenance should be started only after the tool is completely inoperative.**



### DANGER

**Wear safety glasses when performing this test. Never perform this test near an open flame or sparks, while smoking, or where the fuel might get in your eyes.**

## Fuel Cell Check

If the nailer's fan operates and the light is green but the tool will not cycle consistently or at all, check the fuel cell. First remove the fuel cell from the tool and check the "Best Use Before" date stamped on the bottom. If it is beyond this date, the fuel cell may not consistently dispense the proper amount of fuel – even if the fuel cell has never been used. To test if the fuel cell still dispenses fuel:

1. Hold the fuel cell in the upright position with the flat bottom toward the ground – this orientation is important for a proper test.
2. Gently push the tip of the fuel cell cap against a solid object five times.
3. A small amount of fuel should be released all five times.
4. If fuel is not released every time it indicates the fuel cell is empty or expired\* and must be replaced.

\* Expired fuel cell may dispense fuel when upside down or sideways but will not work more than a couple of times in the upright position because of the reduced internal pressure (see page 10 for more information).

## Battery Check

Periodically check the battery indicator lights in the handle of the Cordless Nailer. When encountering a problem, the first step should always be to make sure the battery has enough charge to operate the tool.

When you first insert the battery into the ON position, the battery indicators in the handle will show the battery status. While nailing, press the rapid fire button at any time for a quick read of battery status. See Battery Indicator Lights section on Page 9 for additional information.

## Clearing a Jam

An occasional problem you may encounter is a jammed fastener. Because of the unique design of the Cordless Framing Nailer, clearing a jammed fastener is easy:

Push the lever in the follower to release the fasteners.



Loosen the (2) magazine mounting screws with the 5/32 hex key.

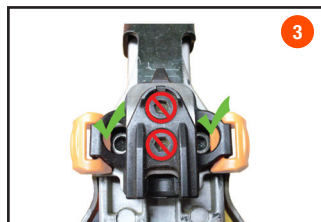

Pull handle/magazine away from the nose of the tool and clear jam.

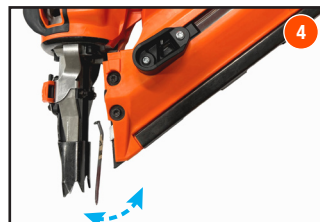

Realign handle/magazine to nose, and tighten mounting screws.



Remove the Paslode Framing Fuel Cell and battery.

# Servicing



## **Cleaning the Air Filter**

Open the grille by pressing slightly above the adapter, and pivoting the cover open. The air filter simply lifts out.

Tap the filter GENTLY to remove any dust. Check and clean the air filter every two days. Soap and water restores the filter to a "like new" condition.

## **End-of-Workday Routine**

At the end of each workday, conduct an end-of-workday routine.

These simple steps are based on maintaining the safety and operational efficiency of the Cordless Nailer.

Before you leave the work site:

1. Remove battery and store in tool case. Always use the Cordless Nailer Case for transporting and storing the tool.
2. Dispose of all empty fuel cells (see page 11). Remember to dispose of fuel cells where they will not be crushed, punctured, burned, or found by children.

When you get home:

1. Place the battery in its charger if it needs charging as indicated by the red charge light on the handle.
2. Wipe your Cordless Nailer with a clean, soft cloth.
3. Remove and clean the filter if needed.
4. Check the Probe to ensure it is operating freely.



## **WARNING**

Make certain magazine mounting screws are tight and magazine is tight to nose. Attempting to fire tool with a loose magazine will result in loss of nail control, damage to tool, or nail discharge toward operator.

## **Tool Cleaning and Oiling**

Periodic cleaning and oiling are necessary to keep the Paslode Cordless Nailer operating properly. The tool should be cleaned and lubricated at least every 50,000 cycles. This number may vary depending upon the rate at which the tool is used and the operating conditions it is used in. The chart in the cleaning instructions will help you determine how often the tool should be cleaned.

## **Cordless Framing Nailer Paslode Cordless Tool Accessories**

A variety of accessories are available for the Paslode Cordless Framing Nailer:

### **No-Mar Work Contacting Element**

USA Part No. 901252

### **Battery**

USA Part No. 902654

### **Clear Safety Glasses**

USA Part No. 401382

### **Paslode Lubricating Oil**

USA Part No. 401482

### **Battery Charger**

USA Part No. 902667

### **Paslode Cordless Framing Nailer Case**

USA Part No. 905607

Contact your Paslode® representative for additional information.

### **Tools**

A 5/32 Hex Socket Wrench (Part No. 401331) is provided with each Paslode Cordless framer.

# Tool Schematic

## Parts Legend CF325XPRO24 CORDLESS XPRO 30° FRAMING NAILER 906800; 906800DHL

1	901063	Shoulder Screw	4	59	906858	Retaining Ring Mod	1	
2	906305	Grille	1	60	900593	Screw, SEMS SHCS 10-24 x 5/8	3	
3	900315	Filter	1	61	906606	XPRO Nail Claw	1	
4	906805	XPRO Cap	1	62	502020	Compression Spring .240 x .813	1	
5	900902	Screw, SEMS, 8-32 x 5/8 Thread Forming	3	63	906337	Bypass Follower Roll Pin	1	
6	902637	Travel Limiter	1	64	906607	Follower Body, Unit B	1	
7	900286	Spark Plug Assembly, Includes O-Ring	1	65	906605	Follower Body, Unit A	1	
8	401356	Motor Sleeve	1	66	337600	Follower Screw	2	
9	906817	Clip, Cylinder Head	1	67	900594	Screw, SEMS, 8-32 x 1/2	4	
10	900596	Screw, SEMS, 8-32 x 7/16 Thread Forming	3	68	906615	Shearblock, US	1	
11	904546	Fuel Tube	1	69	404457	Spring/Switch CT	1	
12	905606	Fuel Block	1	70	404451	Bar/Follower Lockout (CT)	1	
13	902211	Fuel Pivot Arm	1	71	906612	Spring Retention Pin	1	
14	904517	Fuel Barb	1	72	906608	Assembly, Pin Drum and Spring	1	
15	902213	Pivot Arm Pin	1	73	902220	Channel Magazine	1	
16	906816	Framing Cylinder Head	1	74	404441	Plate/Cover-Mag (CT)	1	
17	900935	Ring Seal (Cylinder Head)	2	75	906619	Wear Channel	1	
18	403167	Fan Assembly	1	76	906848	Warning/BF Label	1	
19	900969	Screw, Thread Forming, 8-32 x 5/8	1	77	902230	Pin, Fuel Door	1	
20	906339	Combustion Chamber Ring	1	78	902209	Fuel Door Actuator	1	
21	900481	Seal, Combustion Chamber	1	79	902235	TX-15 Ring	1	
22	906814	Flat Head Screw 8-32 x 0.5 T20	2	80	902210	Dosing Lever	1	
23	906812	Plate, Combustion Chamber	1	81	902237	Utility Hook	1	
24	906811	XPRO Combustion Chamber	1	82	902238	Spring-Utility Hook	1	
25	404827	Pin (CT)	2	83	902227	Utility Hook Button	2	
26	401328	Retaining Ring, Bowed	1	84	901222	Shoulder Screw (CT)	2	
27	401461	Ring/Piston (IM325/CT)	2	85	404448	Roller Lever Assembly	1	
28	404421	Piston (CT)	1	86	900597	Screw, SEMS, #6-19 x 3/8 48 Thd. Forming	1	
29	404420	Driver Blade (CT)	1	87	906803	XPRO Right Handle	1	
30	905601	Bumper	1	88	902621	Foam Pad / Battery	1	
31	404464	Stop/Rubber (CT)	2	89	906829	XPRO Clip, MSU Wire	1	
32	404411	Spring/Chamb Return	2	90	404702	Screw / Thread Form	4	
33	900934	Seal Ring (CT)	2	91	906835	MCB BFSW Assembly	1	
34	906602	Sleeve	1	92	404927	Spring / Trigger (CT)	1	
35	404426	Exhaust Baffle	2	93	404435	Trigger (CT)	1	
36	404425	Reed Plate	1	94	906825	XPRO MSU Assembly	1	
37	404424	Valve/Reed (CT)	1	95	401450	Foam Pad / Connector MSU	1	
38	900595	Screw, SEMS, 8-32 x 3/8 Thread Forming	2	96	906802	XPRO Left Handle	1	
39	404422	Muffler (CT)	1	97	906853	Label, Nameplate (US)	1	
40	404423	Cover/Muffler (CT)	1	98	900453	Screw, #8-16 x 7/8 48-2 Plastite	4	
41	902249	Wear Plate, Nose	1					
42	403816	Screw/SHC (CT)	2	<b>SUB-ASSEMBLIES</b>				
43	404445	Bushing/Shear Block (CT)	2	A1	906804	Assembly, XPRO Cap	1	
44	901249	Upper Probe	1	A2	902635	Assembly, Fan Motor	1	
45	401380	Bar/Tie (IM325CT)	1	A3	906810	Assembly, Combustion Chamber	1	
46	902620	Button-Probe Release	2	A4	404485	Assembly, Driver Blade	1	
47	902619	Probe Release	1	A5	906603	Assembly, Sleeve	1	
48	901238	Flat Spring (CT)	1	A6	906820	Assembly, Magnet Cartridge	1	
49	901241	Probe Stop (CT)	1	A7	906604	Assembly, Follower	1	
50	900592	Screw, SEMS SHCS 10-32 x 1/2	2	A8	902295	Assembly, Fuel Door	1	
51	906863	Lower Probe	1	A9	906818	Assembly, Cyl Head Wire Clip	1	
52	906859	Foam Pad	2	A10	906865	Assembly, Housing with Labels	1	
53	906823	Grommet	1					
54	906821	Magnet Cartridge	1					
55	906822	Magnet Assembly	1					
56	906801	XPRO Housing	1					
57	918919	Paslode Logo	1					
58	906311	Paslode Label	1					



# Tool Schematic

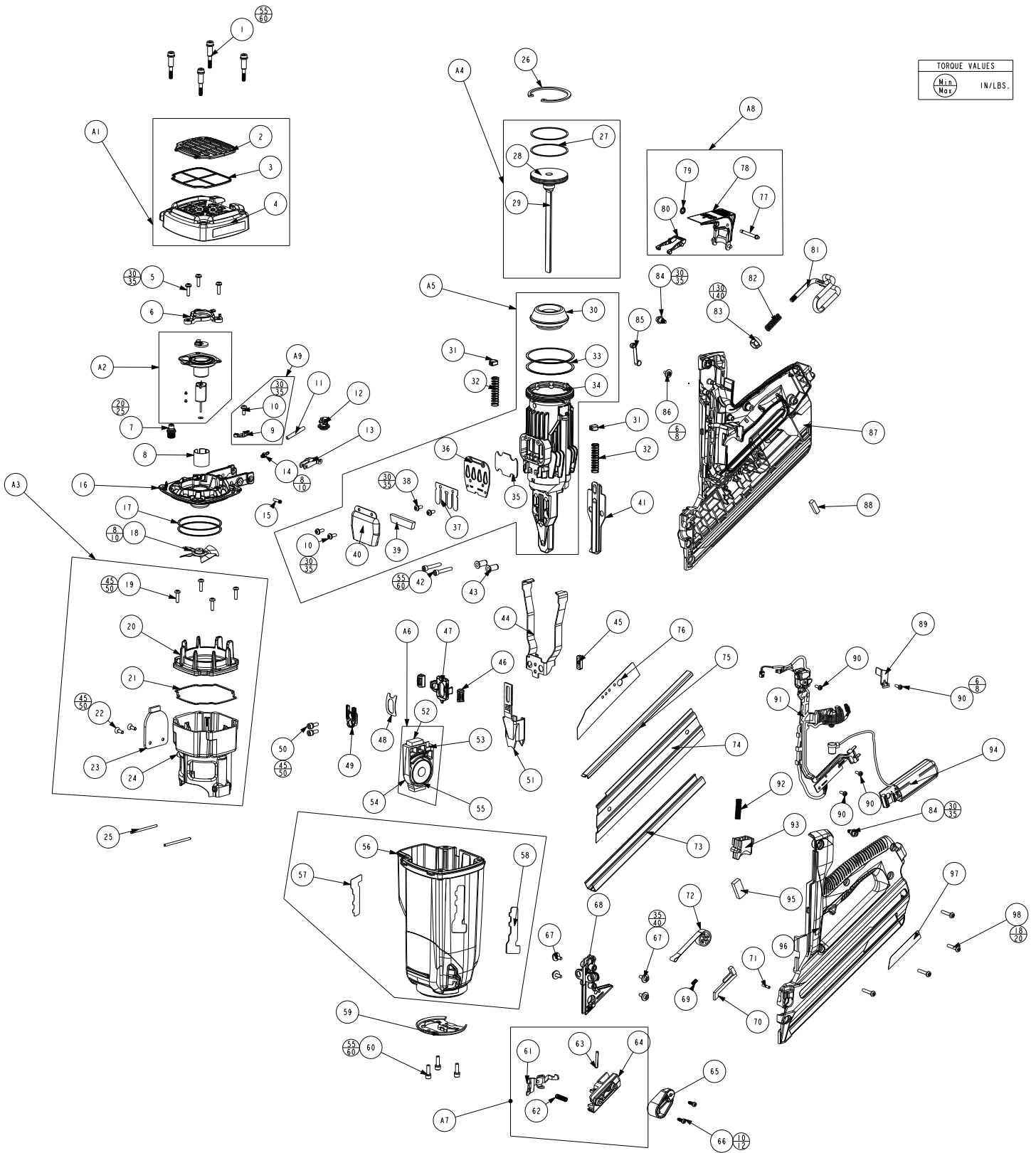

# Troubleshooting

## LED Diagnostic Codes

The LED above the low battery icon will flash if the tool is having any of the below errors.

Error Code Diagnostics Table	
Number of Flashes	Error
1	Fan Short
2	Magnet Short
3	Fan Open / Stall
4	Magnet Open
5	Bumpfire LED <sup>(1)</sup>
6	Bumpfire Switch <sup>(1)</sup>
7	Ignition

Each flash will be ON 250mS followed by OFF 500mS. After the diagnostic code flash(es) there is a 3 second OFF pause. Then the diagnostic flash(es) repeat.

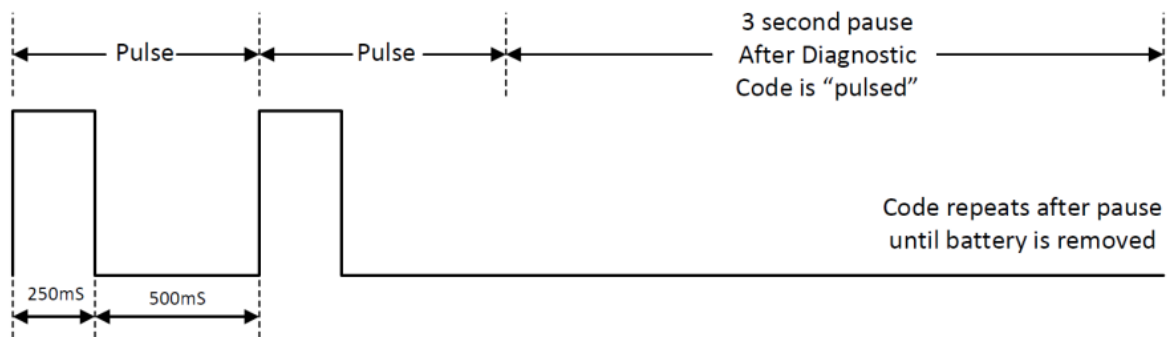

## Preparing Tool for Operation - Battery/Charger Problems

SYMPTOM	POSSIBLE PROBLEMS	SERVICE
Battery does not appear to accept charge when the battery and charger are plugged into the wall mount adapter.	Inoperative indicator lights on charger, or defective charger.	Try battery in tool after a full charge cycle. If tool LED is green, charger is not working properly. Replace charger, or monitor charging time to ensure battery has adequate time for recharging. It is normal for battery to feel warm after properly charging.
Battery charger flashes red/green for more than 20 minutes.	Defective battery.	Replace battery.
	Battery damaged or cycle life exhausted.	Replace battery.
Charger gets hot, makes excessively loud noise, or smokes during charging cycle. Charger cord or wall plug gets hot.	Damaged charger.	Discontinue use immediately and unplug from power source. Replace charger and tag or dispose of charger to prevent accidental reuse or connection to power source.

## Normal Stage of Operation

SYMPTOM	POSSIBLE PROBLEMS	SERVICE
Fan does not run	Refer to Error Codes Diagnostics Table	

# Troubleshooting

## Normal Stage of Operation

SYMPTOM	POSSIBLE PROBLEMS	SERVICE
Tool operates properly, but fasteners do not drive fully.	Work-contacting element requires adjustment.	Adjust work contacting element.
	Dirty air filter.	Clean filter.
	There may be loss of seal in combustion chamber.	Press work contacting element against workpiece for 20 seconds. Pull trigger. If fastener does not drive, there is a leak that requires service.
Tool operates, but no fastener is driven.	Wrong fasteners being used.	Use only fasteners meeting Paslode® specifications. Check Fasteners and Applications section for fastener types and sizes recommended for use in Cordless tool.
	Tool requires cleaning.	Follow Paslode Cordless Framing Nailer Cleaning Instructions.
	Follower not properly engaged behind fastener strip.	Position follower behind fastener strip and engage strip.
	Jammed fastener.	Clear jam.
Tool operates erratically or appears to be losing power - tool indicator light is green.	Spark plug wire is loose.	Check spark plug wire.
	Filter element is dirty, causing tool to overheat.	Remove filter element and clean. Use soap and water to remove stubborn debris.
Tool operated and drove fasteners, but driver blade did not return to up position.	Built-up dirt and debris on driver blade or in nose bore.	Clean driver blade and nose bore with degreaser cleaner.
	Mid check is dirty or disabled.	Return tool to authorized Paslode® Cordless dealer for service.
Combustion chamber does not drop after tool cycles.	Work-contacting element is bent or is dirty.	Clean or replace work-contacting element.

### **For US Region Only**

If you need further assistance, please visit:  
[paslode.com/service-retail-locator](http://paslode.com/service-retail-locator)  
 to find your closest service center.

### **For technical support call:**

**1-800-222-6990**

**or email:**

**tech@paslode.com**



An Illinois Tool Works Company  
 155 Harlem Avenue  
 Glenview, IL 60025  
[www.paslode.com](http://www.paslode.com)

# Troubleshooting

	Battery is not charged.	Charge battery.
	Battery terminals are oily, dirty, or corroded.	Clean battery terminals with cloth or pencil eraser.
Fan does not run, or runs slower than normal	Battery is discharged.	Charge battery.
Work-contacting element does not depress fully - tool does not operate.	Four (4) or less nails in tool.	Load strip of nails.
	Lockout bracket is stuck in lockout position.	Check lockout. If the lockout is stuck or not working properly, stop using the tool and return to an authorized Paslode dealer for service.
	Work-contacting element is bent, worn or at the deepest setting.  Follower is not behind fasteners.	Remove and inspect lower probe. Clean, adjust or replace lower probe as required.  Position follower behind fasteners.
Tool will not cycle - fan runs, LED 1 is solid green.	Paslode Framing Fuel Cell empty or past the "Best Use Before" date stamped on the bottom of the fuel cell.	Replace Paslode Framing Fuel Cell. See page 16 for details on how to check fuel cells.
	Spark plug is dirty.	Clean tool cylinder head and spark plug.
	No spark is generated.	Return tool to authorized Paslode® dealer for service.
Tool blank fires – combustion occurs but no nail comes out of the tool	Dirty or sticky sleeve bore.	Follow Paslode Cordless Framing Nailer Cleaning Instructions.

If tool will not operate after following the above service directions, return the tool to an authorized Paslode® representative for service.



### Still not working? Here are more options:

- Your nailer may qualify for our Cordless 2 Year Service Promise. Visit [paslode.com](http://paslode.com) for more information, or call us at 1-800-222-6990.
- Keep you Cordless Nailer in top form. Visit [paslode.com](http://paslode.com) and watch our Cleaning and Maintenance videos

*Work all day, every day—  
if your nailer stops for  
any reason, we'll fix it.  
No questions. No hassles.  
NO COST!*



**Paslode®**  
An Illinois Tool Works Company  
155 Harlem Avenue  
Glenview, IL 60025  
[www.paslode.com](http://www.paslode.com)